

n o
t h i n g
b u t
w u n
d e r
b a r .



OVERVIEW ROLF BENZ YOKO

**ROLF
BENZ**

OUTDOOR

„Mixing different genres, Rolf Benz YOKO combines the clean lines of German design with a Zen spirit and a light French/Italian touch.“

Toan Nguyen



- The new outdoor range comprises a sofa, armchair, lounge, chair and table.
- “Yoko” (Japanese for sun) epitomises the beneficial effects of the sun and looks equally good in urban and rural settings.
- Designer Toan Nguyen creates a connection between excellent design and meaningful use.
- All frames are based on an aluminium framework that rests on elegantly curved legs and has an coloured powder coating in anthracite and bianco (excluded are chair and table). The brilliant, subtly shimmering finish that was developed for exteriors makes the furniture robust and weatherproof whilst looking extremely elegant at the same time.
- The fabrics in the cover collection are equally weather-resistant and their colour coordinates with the aluminium frame. Optionally, you can choose bouclé fabrics made from 3D yarn or fabric combinations for the cushions and body. All covers are removable and washable at 30°.
- The straps of the sofa frame and the cord of the weaving in the chair and armchair serve as both a spring system and as decorative stylish elements that are coordinated with the colour of the pedestal.

**ROLF
BENZ**

OUTDOOR

„Bianco is a colour that is especially on trend outdoors, highlighting the other cover colours and giving the furniture a Mediterranean feel. Bianco reminds us of the whitewashed façades of Mediterranean villages that bring out the blue of the sea.“

Bettina Hermann, Director Design & Productmanagement

„The neutral colour anthracite fits always and to all fabrics of the Rolf Benz Outdoor collection“

Bettina Hermann, Director Design & Productmanagement

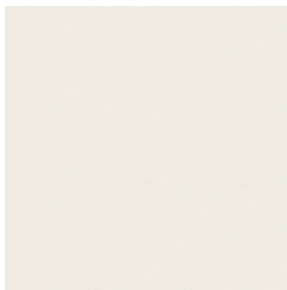

Bianco



Anthracite

Sofa | Rolf Benz YOKO 219 | Design Toan Nguyen



**ROLF
BENZ**

OUTDOOR



**ROLF
BENZ**

OUTDOOR

Sofa | Rolf Benz YOKO 219 | Design Toan Nguyen



- Toan Nguyen has developed a principle for the Rolf Benz YOKO sofa range that is formally impressive and ensures ultimate flexibility. On a seat frame with straps, back and seat cushions, shelving and peripheral insertion brackets made of high-grade steel, you can easily design sofas, corner sofas, recamières, sunbathing areas or face-to-face arrangements with and without shelving – and redesign them again in the blink of an eye.
- Depending on the sofa size or the required arrangement, the seat cushions are available in various lengths; the backrest cushions are attached and optionally enhanced with side section cushions or a side section bolster cushion.

**ROLF
BENZ**

OUTDOOR

Sofa | Rolf Benz YOKO 219 | Design Toan Nguyen



**ROLF
BENZ**

OUTDOOR

PRODUCT FEATURES OF THE ROLF BENZ YOKO SOFA:

1. Selection of sofa frame (with straps) made of matt powder-coated aluminium/stainless steel:

I Dimensions: 80, 160, 240 cm x 90 cm

I Colour:

- Bianco fine-grain matt
- Anthracite matt

The frames have insertion points for the brackets. All elements of the frame can be linked to each other.

2. Selection of seat cushions or shelving:

I Dimensions: 80, 160, 240 cm x 93 cm

(These can be individually selected; the size of the frame does not determine the size of the seat cushion.)

I Colour: Rolf Benz Outdoor cover collection

Shelving made of matt powder-coated aluminium:

I Dimensions: 80 cm x 90 cm

I Colour:

- Bamboo
- Teak
- Ceramic Calacatta smooth
- Ceramic Naturali, Pietre

If shelving is selected in conjunction with cushions, the arrangement can subsequently be changed in any order.

! A high-quality, especially casual upholstery that forms waves/leaves
■ indentations that are typical of the material – this waviness may even occur in new condition. All measurements are approximate.

3. Selection of the backrest/side section elements:

Choose insertable brackets to suit the back/side section element.

The brackets can be inserted anywhere in the frame at any insertion point.

I Insertable brackets made of matt powder-coated high-grade steel:

- Backrest brackets for backrest cushions: 44 x 46 cm
- Side section bracket for cushions: 44 x 26 cm
- Side section bracket for bolster cushion: 44 x 28,7 cm

I Colour (corresponds to the sofa frame):

- Bianco fine-grain matt
- Anthracite matt

4. Selection of the backrest and side section cushions/bolster cushion:

The appropriate cushions are selected based on the bracket:

I Backrest/side section element:

- Backrest cushion 77 cm x 41 cm
- High backrest cushion 77 cm x 49 cm
- Side section cushion 31 cm x 55 cm
- Side section bolster cushion 18 cm x 60 cm
- Accessory cushions 60 x 40 cm, 50 x 50 cm, 40 x 40 cm

I Colour: Rolf Benz Outdoor cover collection

I Selection of accessories:

- Cover: An appropriate cover for the selected frame is recommended for the sofa.

**ROLF
BENZ**

OUTDOOR

Sofa | Rolf Benz YOKO 219 | Design Toan Nguyen

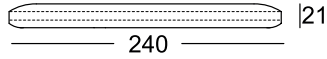
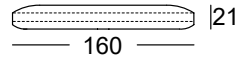
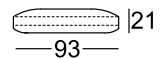
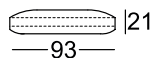
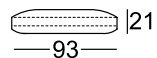
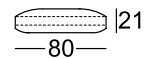
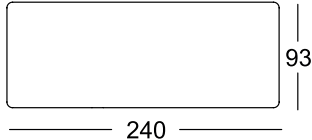
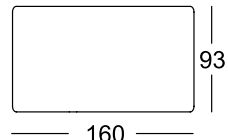
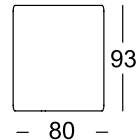
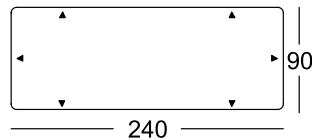
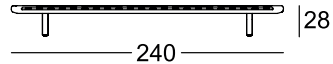
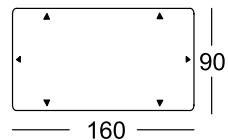
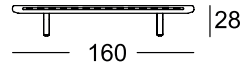
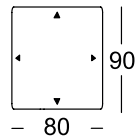
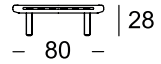
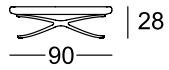

Sofa | Rolf Benz YOKO 219 | Design Toan Nguyen

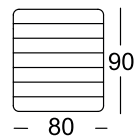
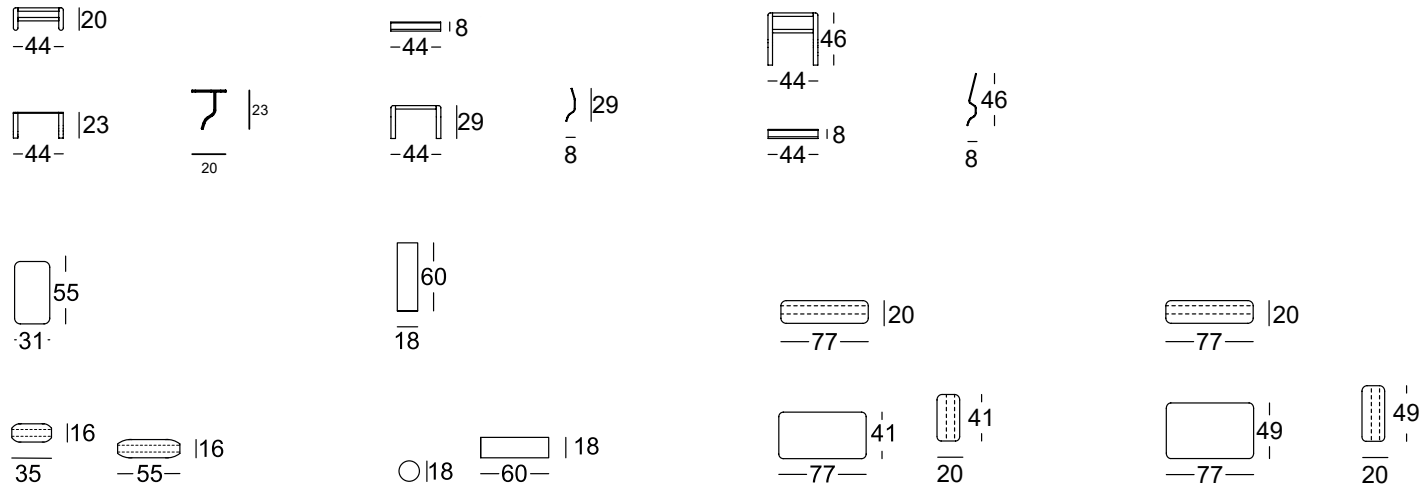

Teak:

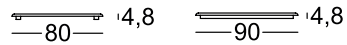

Bamboo:



Ceramic:

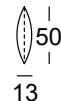
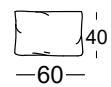
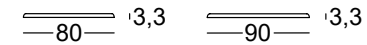

Combination examples sofa | Rolf Benz YOKO 219 | Design Toan Nguyen

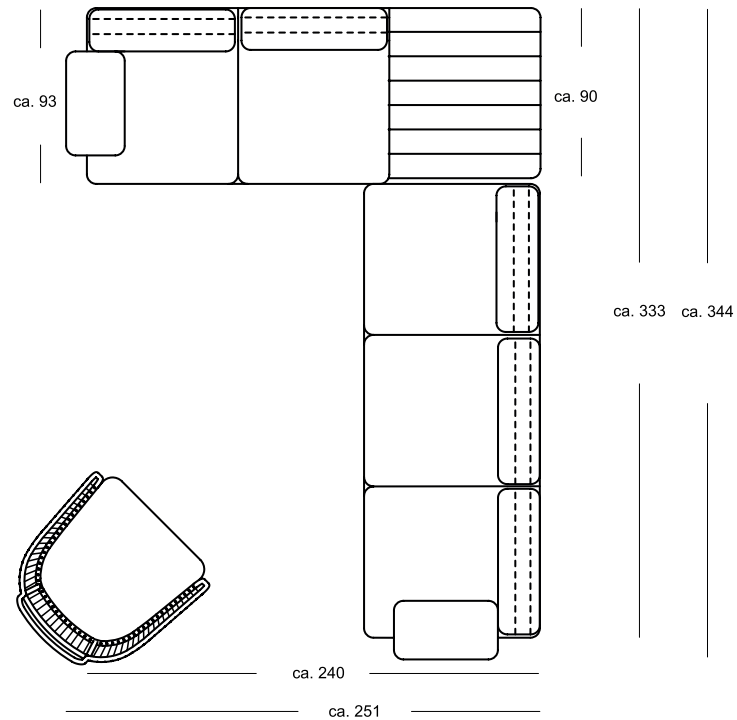

Frame 219/240 2 x
 ST-KI Elem 219 MET 2 x
 RU-Elem 219 MET 5 x

ST-KI 219 2 x
 ABL 219/80 bamboo

SIK 219-80 5 x
 RUK 219/77 5 x

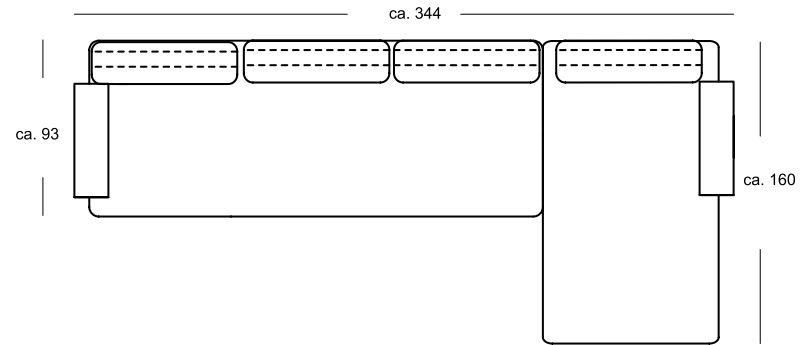

Frame 219/240 1 x
 Frame 219/160 1 x

ST-RO-Elem 219 MET 2 x

RU-Elem 219 MET 4 x
 SIK 219-240 1 x

SIK 219-160 1 x
 RUK 219/77 3 x
 H-RUK 219/77 1 x

ST-RO 219 2

Combination examples sofa | Rolf Benz YOKO 219 | Design Toan Nguyen

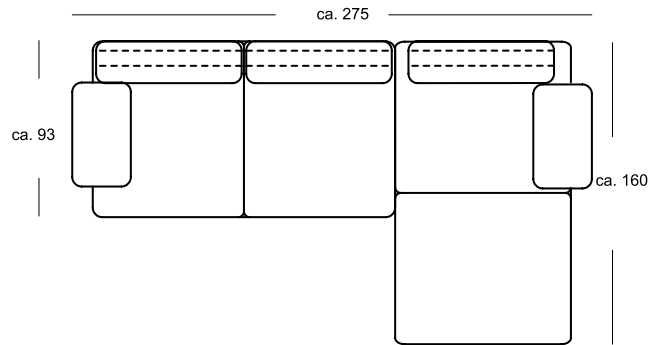

Frame 219/160 2 x

ST-KI-Elem 219 MET 2 x

RU-Elem 219 MET 3 x

SIK 219-80 4 x

RUK 219/77 3 x

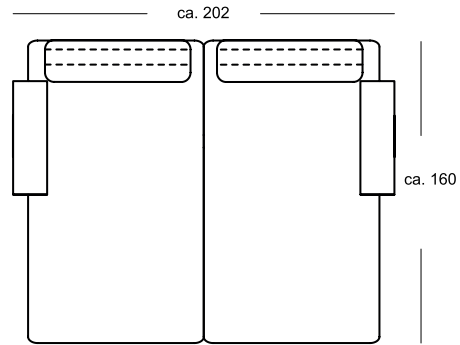

Frame 219/160 2 x

ST-RO-Elem 219 MET 2 x

RU-Elem 219 MET 2 x

SIK 219-160 2 x

H-RUK 219/77 2 x

ST-RO 219 2 x

Combination examples sofa | Rolf Benz YOKO 219 | Design Toan Nguyen

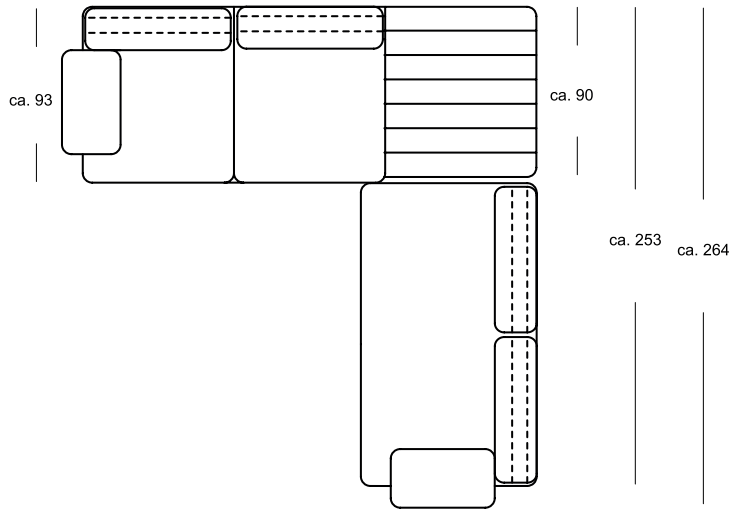

- Frame 219/240 1 x
- Frame 219/160 1 x
- ST-KI-Elem 219 MET 2 x
- RU-Elem 219 MET 4 x
- SIK 219-80 2 x
- SIK 219-160 1 x
- RUK 219/77 4 x
- ST-KI 219 2 x
- ABL 219/80 bamboo

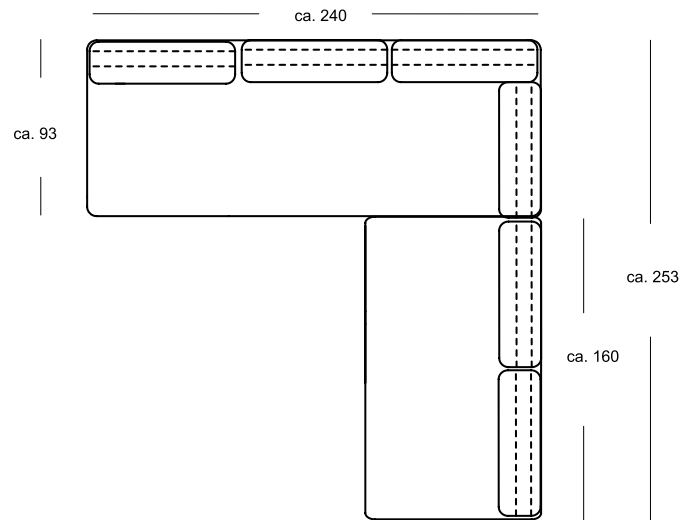

- Frame 219/240 1 x
- Frame 219/160 1 x
- RU-Elem 219 MET 6 x
- SIK 219-240 1 x
- SIK 219-160 1 x
- RUK 219/77 5 x
- H-RUK 219/77 1 x

**ROLF
BENZ**

OUTDOOR

Armchair | Rolf Benz YOKO 271 | Design Toan Nguyen



**ROLF
BENZ**

OUTDOOR

Armchair | Rolf Benz YOKO 271 | Design Toan Nguyen



- See, love, sit down. As an armchair, Rolf Benz YOKO has a wonderful emotional appeal. With its generous seat depth and backrest that is tilted ergonomically backwards, it's a real feel-good, cosy armchair.
- The frame has weaving made of thin cord that exudes an air of warmth. You are free to choose the covers for the seat, backrest and side section cushions, if required with an additional footstool. The seating area of the armchair and stool are made of a high-quality Batyline fabric.

**ROLF
BENZ**

OUTDOOR

PRODUCT FEATURES OF THE ROLF BENZ YOKO ARMCHAIR:

1. Selection of the armchair frame made of matt powder-coated aluminium:

I Dimensions: Height 77 cm, width 86 cm, depth 88 cm

I Colour:

- Bianco fine-grain matt
- Anthracite matt

2. Selection of seat cushions (74 x 74 cm) and backrest cushions (68 x 53 cm):

I Colour: Rolf Benz Outdoor cover collection

3. Optional: Side section cushions (set) for armchair (55 x 35 cm)

I Colour: Rolf Benz Outdoor cover collection

4. Optional: Stool (73 x 50 cm, height 29 cm) – available with seat cushions (73 x 50 cm)

I Colour: Rolf Benz outdoor cover collection

5. Optional: Accessory cushions (60 x 40 cm, 50 x 50 cm, 40 x 40 cm)

I Colour: Rolf Benz Outdoor cover collection

6. Selection of accessories:

I Cover: An appropriate cover for the armchair and stool is recommended.

! A high-quality, especially casual upholstery that forms waves/leaves indentations that are typical of the material – this waviness may even occur in new condition. All measurements are approximate.



**ROLF
BENZ**

OUTDOOR

Armchair | Rolf Benz YOKO 271 | Design Toan Nguyen



**ROLF
BENZ**

OUTDOOR

Armchair | Rolf Benz YOKO 271 | Design Toan Nguyen

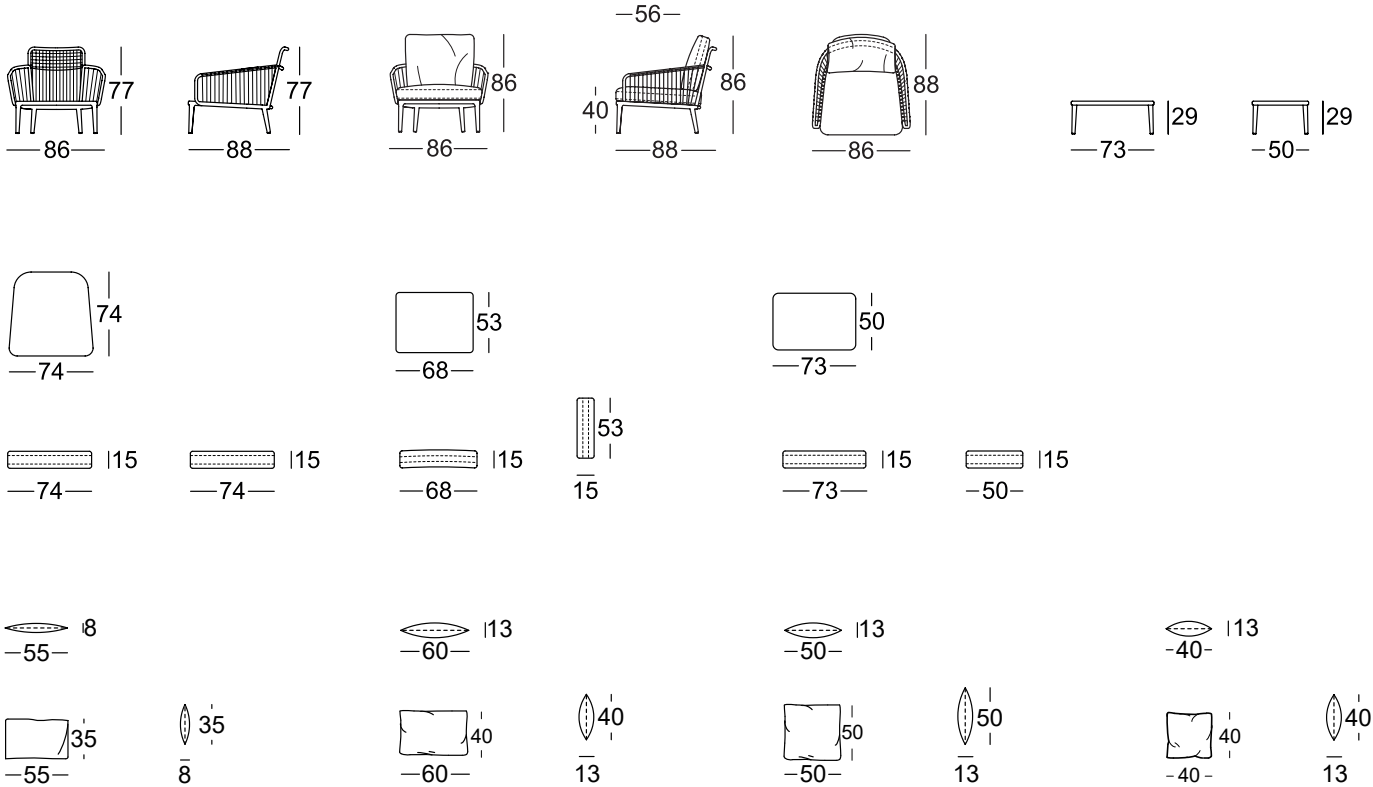

High-back chair | Rolf Benz YOKO 271 | Design Toan Nguyen



- Our high-back chair provides even greater seating comfort and encourages you to sit back and relax.
- The high-back chair with its striking form stands out while the hand-braided cording of thin rope exudes a special warmth and blends in with any environment.
- The high-back chair is available in bianco fine-grain matt and anthracite matt.

Product features high-back armchair | Rolf Benz YOKO 271 | Design Toan Nguyen

PRODUCT FEATURES OF THE ROLF BENZ YOKO HIGH-BACK ARMCHAIR:

1. Selection of the high-back armchair frame made of matt powder-coated aluminium:

I Dimensions: Height 96 cm, width 87 cm, depth 103 cm
(seat height 29 cm, seat depth 65 cm)

I Colour:

- Bianco fine-grain matt
- Anthracite matt

2. Selection of seat cushions (73 x 79 cm) and backrest cushions (61 x 79 cm):

I Colour: Rolf Benz Outdoor cover collection

3. Optional: Stool (73 x 50 cm, height 29 cm) – available with seat cushions (73 x 50 cm)

I Colour: Rolf Benz Outdoor cover collection

4. Optional: Side section cushions (set) for high-back armchair (55 x 35 cm)

I Colour: Rolf Benz Outdoor cover collection

5. Selection of accessories:

I Cover: An appropriate cover for the high-back armchair and stool is recommended.

! A high-quality, especially casual upholstery that forms waves/leaves indentations that are typical of the material – this waviness may even occur in new condition. All measurements are approximate.



**ROLF
BENZ**

OUTDOOR

High-back armchair | Rolf Benz YOKO 271 | Design Toan Nguyen

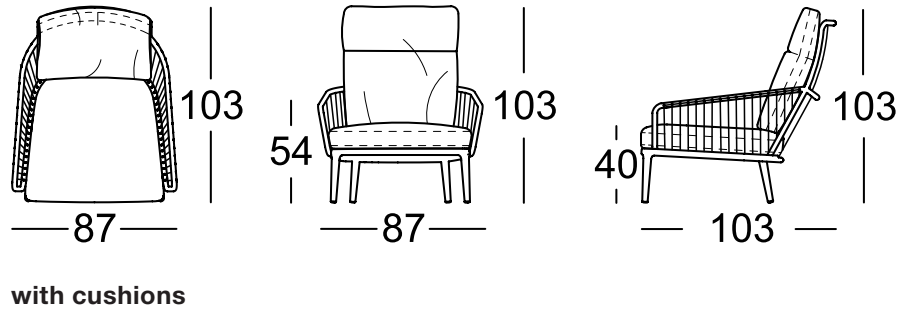
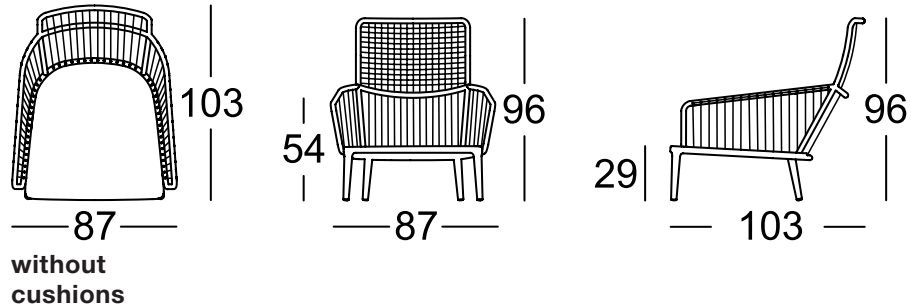

Rocking chair | Rolf Benz YOKO 271 | Design Toan Nguyen



- The unique design of Rolf Benz YOKO is also reflected in the rocking chair, which is available in anthracite and bianco.
- Its aluminium frame and veneered feet create a natural sensuality.
- High-quality runners made of teak and bamboo provide a pleasant rocking sensation.
- Its delicate appearance makes the rocking chair a real highlight in any outside area.

PRODUCT FEATURES OF THE ROLF BENZ YOKO ROCKING CHAIR:

1. Selection of the rocking armchair frame made of matt powder-coated aluminium:

- | Dimensions: Height 96 cm, width 87 cm, depth 103 cm (seat height 29 cm, seat depth 70 cm, side section height 54 cm)
- | Colour:
 - bianco/teak
 - bianco/bamboo
 - anthracite/teak
 - anthracite/bamboo

2. Selection of seat cushions (73 x 86 cm) and backrest cushions (65 x 18 cm):

- | Colour: Rolf Benz Outdoor cover collection

3. Optional: Stool (73 x 50 cm, height 29 cm) – available with seat cushions (73 x 50 cm)

- | Colour: Rolf Benz Outdoor cover collection

4. Optional: Side section cushions (set) for rocking chair (55 x 35 cm)

- | Colour: Rolf Benz Outdoor cover collection

5. Selection of accessories:

- | Cover: An appropriate cover for the rocking chair is recommended.

- ! A high-quality, especially casual upholstery that forms waves/leaves indentations that are typical of the material – this waviness may even occur in new condition. All measurements are approximate.



Rocking chair | Rolf Benz YOKO 271 | Design Toan Nguyen

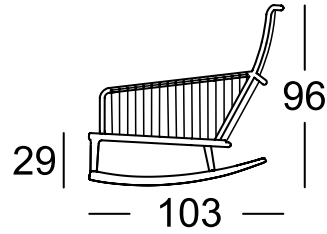
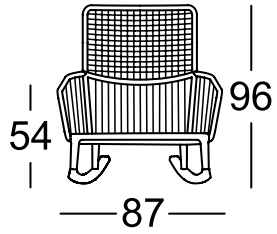
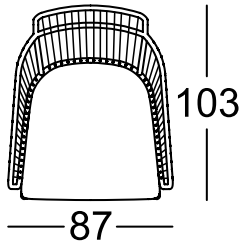

without cushions

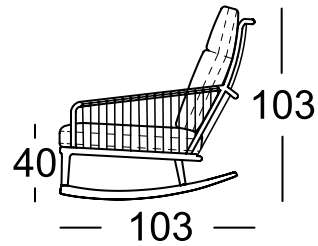
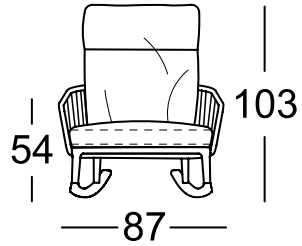
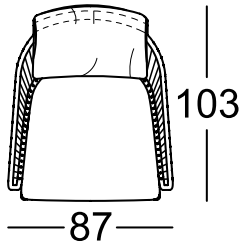

with cushions

Armchair | Rolf Benz Jackout | Design Luca Nichetto



PRODUCT FEATURES ARMCHAIR ROLF BENZ JACKOUT:

1. Selection of armchair frame in stainless steel powder coated in anthracite matt:

- I Dimensions: 99 cm x 106 cm, height 84 cm.
(seat height: 41 cm, seat depth: 43 cm, side panel height: 43 cm)

2. Selection of seat and back cushion

- I Color: cover collection Rolf Benz Outdoor

*Removable seat and back cushions nestle into a breathable, water-repellent seat shell made of outdoor fabric (13% Sunbrella-spun-dyed acrylic, 25% polyester, 64% PVC). Features: stain resistant, UV resistant, mildew resistant, water repellent, breathable.

3. Optional: stool (60 cm x 44 cm, height 46 cm) - available with seat cushion.

- I Color: cover collection Rolf Benz Outdoor

4. Selection of accessories:

- I Cover: to match the armchair
(with or without stool),
a cover is recommended.

! A high-quality, especially casual upholstery that forms waves/leaves indentations that are typical of the material – this waviness may even occur in new condition. All measurements are approximate.



**ROLF
BENZ**

OUTDOOR

Armchair | Rolf Benz Jackout | Design Luca Nichetto

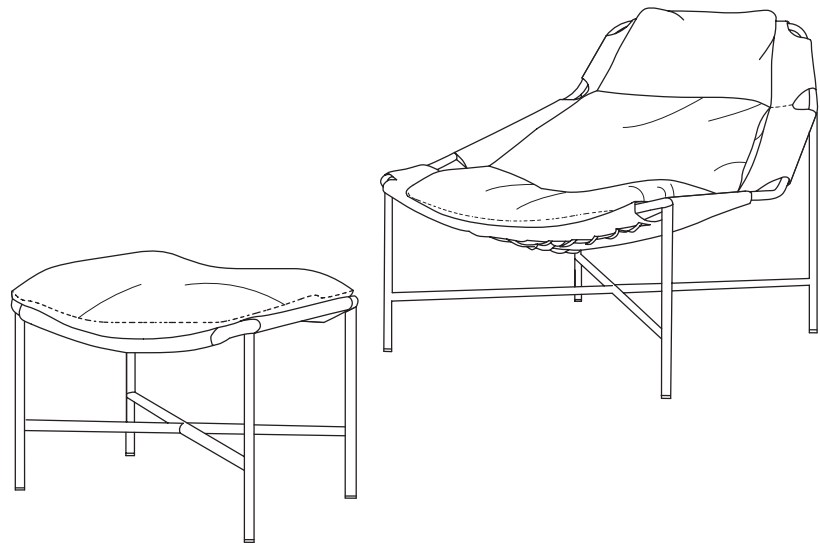
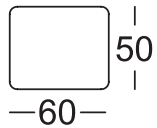
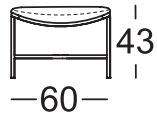
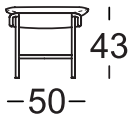
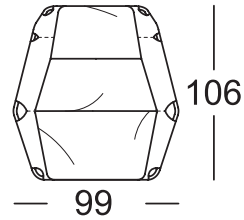
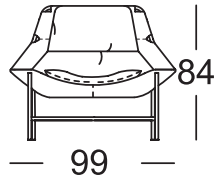
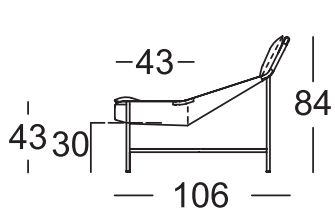

**ROLF
BENZ**
OUTDOOR

New sun lounger | Rolf Benz YOKO | Design Toan Nguyen



- Lying comfort and maximum flexibility – the Rolf Benz YOKO sun lounger is the perfect enhancement to the YOKO Outdoor collection or an elegant standalone item for your downtime outside.
- It combines the art of relaxation with maximum flexibility. An especially soft cushion allows you to literally drift away on it. Thanks to its breathable Batyline covering, you can also use the sun lounger in hot temperatures or after swimming in the pool without the need for an extra layer.
- The airiness of the sun lounger is reflected in the soft radii of the aluminium frame and its simple ease of use: an integrated gas pressure spring provides stepless adjustability. Discreetly inserted rollers mean that Rolf Benz YOKO can easily be moved. Several loungers can be stacked on top of each other (max. 5) for easy storage.

New sun lounger | Rolf Benz YOKO | Design Toan Nguyen



Product features:

1. Selection of lying frame:

- | Dimensions: height 37 cm,
- | Width: 70 cm, Depth 209 cm
- | Colour:
 - Bianco fine-grain matt
 - Anthracite matt

2. Selection of lying cushion:

- | Dimensions: height 8 cm, width 70 cm,
- | Depth: 198 cm
- | Colour: Rolf Benz Outdoor cover collection

3. Optional selection accessory cushion:

- | Dimensions: 60 x 40 cm, 50 x 50 cm, 40 x 40 cm
- | Colour: Rolf Benz Outdoor cover collection

4. Optional selection of cover:

- | Cover: An appropriate cover for the sun lounger is recommended
- ! High-quality, casual upholstery that forms waves/leaves indentations that are typical of the material. All measurements are approximate.

New sun lounger | Rolf Benz YOKO | Design Toan Nguyen

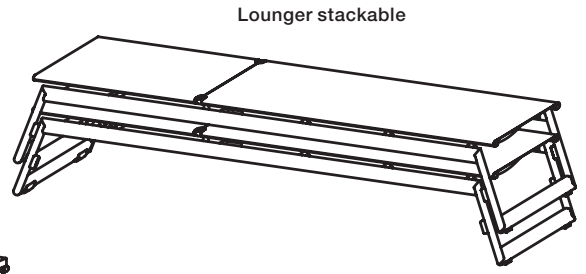
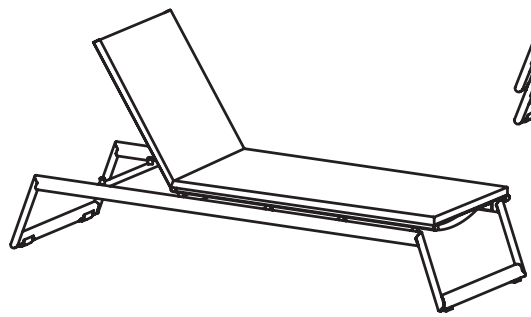
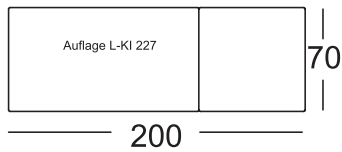
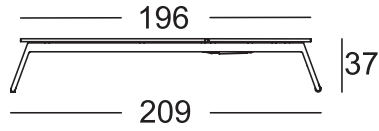
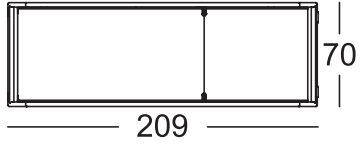
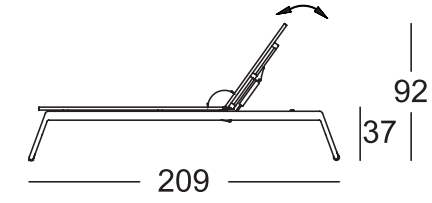
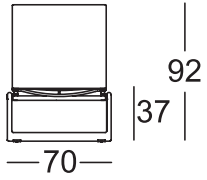

**PRODUCT FEATURES OF THE ROLF BENZ 261
COFFEE TABLE AND SIDE TABLE:**

1. Selection of frame:

- | Dimensions of side table (round): Height 40 cm, table top diameter 41.5 cm
- | Dimensions of coffee table (round): Height 30 cm, diameter of table top 80 cm or 95 cm
- | Frame made of steel painted with zinc-nickel coating:
 - Bianco fine-grain matt
 - Anthracite matt

2. Table top colours:

- Ceramic Calacatta smooth
- Ceramic Naturali, Pietre

3. Selection of accessories:

- | An appropriate cover for the table is recommended.



Product features occasional furniture | Rolf Benz 262 | Design Beck Design

Rolf Benz 262 by Beck Design fits perfectly into the Rolf Benz Outdoor collection, based on a favorite piece from the Rolf Benz Indoor coffee table collection.

**PRODUKTEIGENSCHAFTEN
ROLF BENZ 262**

1. Selection of frame:

- | Dimensions of side table (round): Height 44 cm, table top diameter 50 cm
- | Dimensions of coffee table (round): Height 36 cm, diameter of table top 80 cm or 100 cm
- | Frame made of steel, KTL coated:
 - Bianco fine-grain matt
 - Anthracite matt

2. Table top colours:

- Ceramic Calacatta smooth
- Ceramic Naturali, Pietre

3. Selection of accessories:

- | An appropriate cover for the table is recommended.



**ROLF
BENZ**

OUTDOOR

Chair | Rolf Benz JUA | Design Hoffmann & Kahlejs

PRODUCT FEATURES CHAIR ROLF BENZ JUA:

1. Selection synthetic seat shell

- | Dimensions: 60 cm x 65 cm, height 85/87 cm
- | 2 seat heights: 49 or 51 cm, seat depth: 45 cm, 2 side section heights: 61 or 63 cm
- | Color: umbra gray matt or anthracite matt
- | Four-legged base (powder-coated anthracite matt stainless steel) with optional swivel function

2. Choice of seat and back cushions

- | Color: Rolf Benz Outdoor cover collection

- ! High-quality, casual upholstery that forms waves/leaves indentations that are typical of the material.
- All measurements are approximate.



Chair | Rolf Benz JUA | Design Hoffmann & Kahle

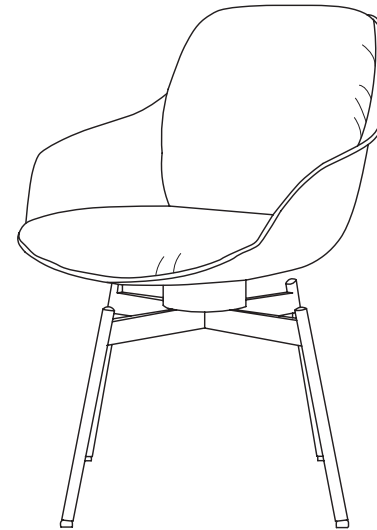
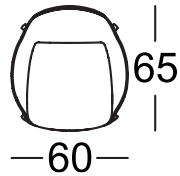
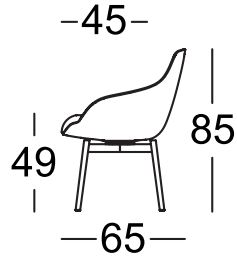
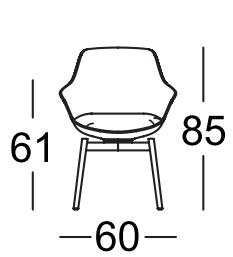
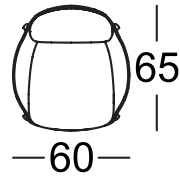
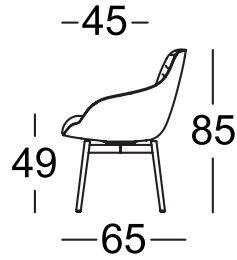
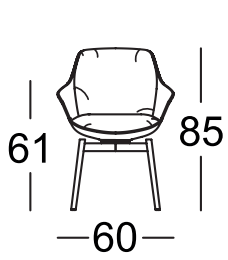

Chair | Rolf Benz YOKO 232 | Design Toan Nguyen



Chair | Rolf Benz YOKO 232 | Design Toan Nguyen



- As a chair, Rolf Benz YOKO also adds a cosy ambience even in minimalistic settings. It combines the lightness of aluminium with the emotional aspect of weaving: The backrest and side sections are designed with elaborately handcrafted weaving to provide perfect comfort even without backrest cushions.
- The ergonomically shaped chair is optionally upholstered with a loose cushion. You can also order an additional backrest cushion if required. The seating area of the chair is made of a high-quality Batyline fabric.
- The Rolf Benz Outdoor fabric collection is available for the covers.



**ROLF
BENZ**

OUTDOOR

PRODUCT FEATURES OF THE ROLF BENZ YOKO CHAIR:

1. Selection of the chair frame:

| Dimensions: Height 78 cm, width 59 cm, depth 61 cm

| Colours:

- Anthracite matt

2. Optional: Seat cushions (46 x 49 cm) and/or backrest cushions (43 x 40 cm)

| Colours: Rolf Benz Outdoor cover collection

3. Optional: Accessory cushions (60 x 40 cm, 50 x 50 cm, 40 x 40 cm)

| Colours: Rolf Benz Outdoor cover collection

4. Selection of accessories:

| An appropriate cover for the chair is recommended.

! High-quality, casual upholstery that forms waves/leaves
■ indentations that are typical of the material. All measurements
are approximate.



**ROLF
BENZ**

OUTDOOR

Dining table | Rolf Benz YOKO 250 | Design Toan Nguyen



Dining table | Rolf Benz YOKO 250 | Design Toan Nguyen

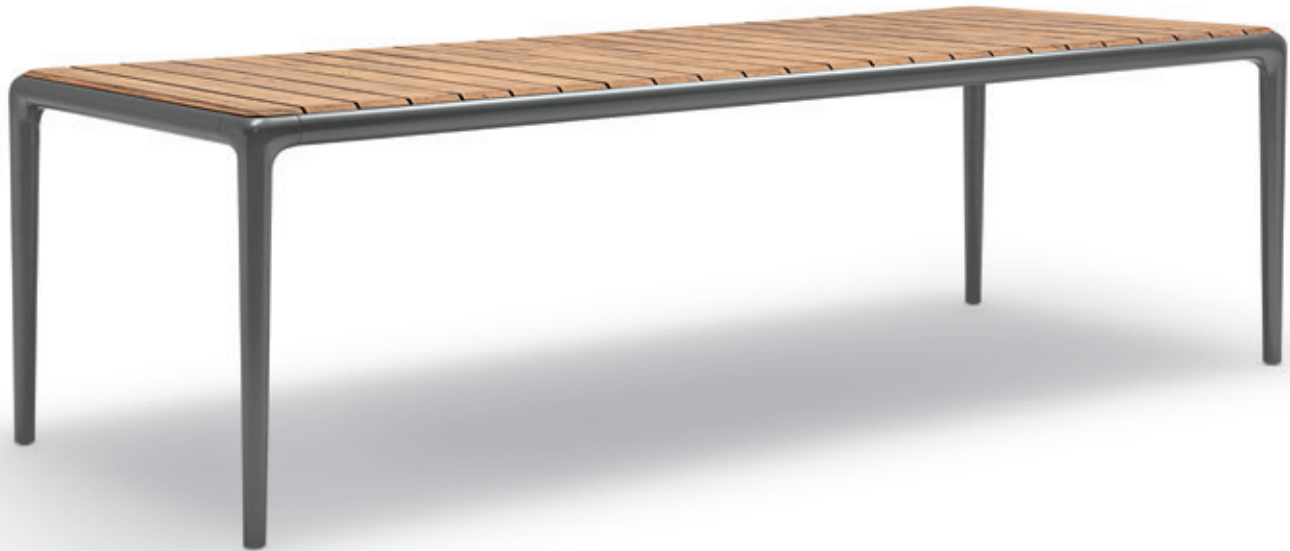

- With the YOKO dining table, Toan Nguyen has created a light-footed base for convivial gatherings. The design vocabulary is clear and the combination of materials is sensual.
- The table is available in several sizes for snacks, dinner, or as an improvised outdoor office.

Product features dining table | Rolf Benz YOKO 250 | Design Toan Nguyen

PRODUCT FEATURES OF THE ROLF BENZ YOKO TABLE:

1. Selection of frame:

| Dimensions: 220 x 100 cm, height: 75 cm, clear dimension lowest point: 68 cm

| Frame made of matt powder-coated aluminium:

- Anthracite matt

| Colour of table leaf:

- Teak

- Ceramic Calacatta smooth

- Ceramic Naturali, Pietre

2. Selection of accessories:

| An appropriate cover for the table is recommended



**ROLF
BENZ**

OUTDOOR

Dining table | Rolf Benz YOKO 250 | Design Toan Nguyen

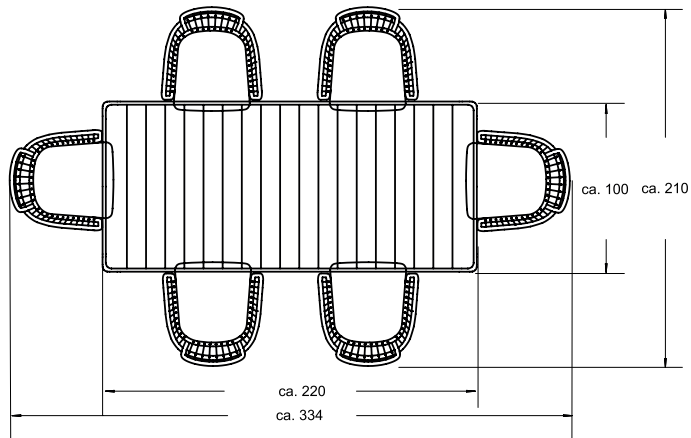

Table 250_220 x 100, 1 x, Chair 232, 6 x

Dining table | Rolf Benz YOKO SUNO | Design Toan Nguyen



Product features dining table | Rolf Benz SUNO | Design Toan Nguyen

PRODUCT FEATURES ROLF BENZ SUNO:

1. Frame selection:

- | Dimensions: 100, 220, 260 x 100 cm, height: 75 cm
- | Frame made of aluminum powder-coated matt in anthracite
- | Inlay plate made of mineral stone mixture

2. Selection of accessories:

- | An appropriate cover for the table is recommended



**ROLF
BENZ**

OUTDOOR

Dining table | Rolf Benz SUNO | Design Toan Nguyen

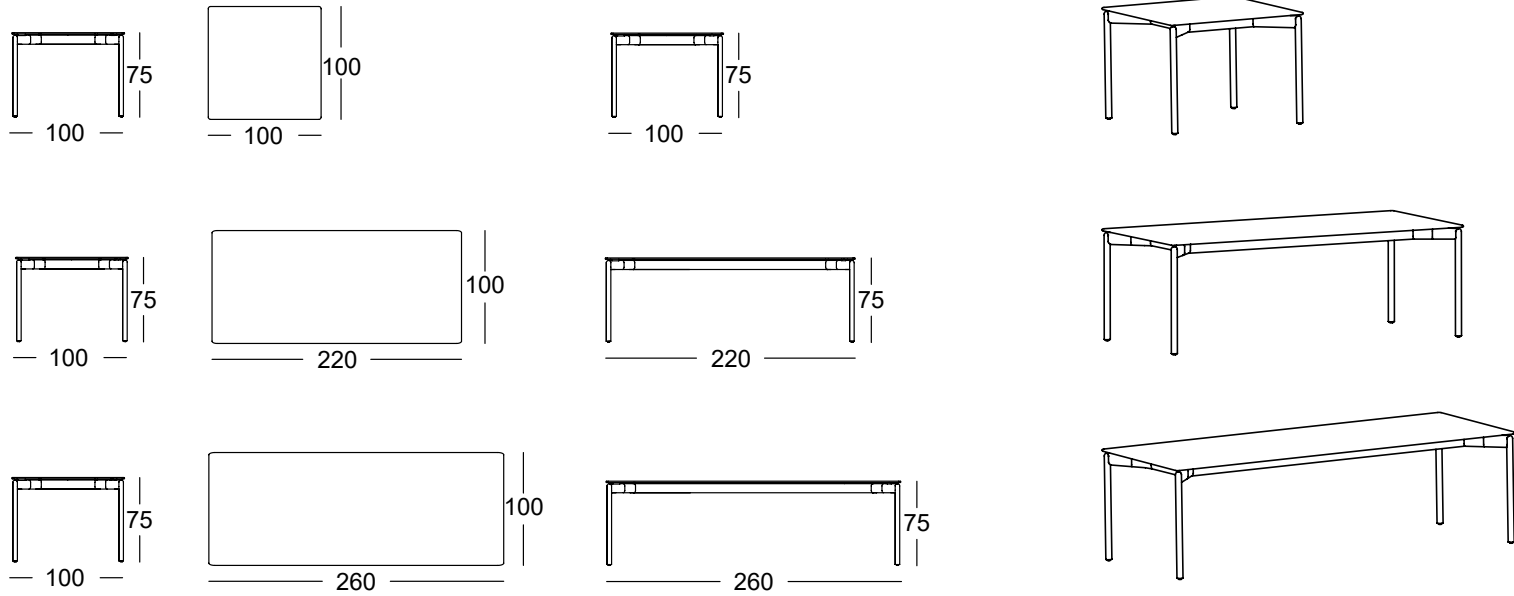

Covers | Rolf Benz YOKO | Design Toan Nguyen



Cover for the sofa



Cover for the table and chairs



Cover for the armchair and stool
Cover for the armchair and stool,
also for high-back armchair and
rocking chair available.



Packaged cover

Fabrics | Rolf Benz Outdoor

The fabrics in the Rolf Benz outdoor collection have been tested according to the strict specifications of our quality requirements. This ensures that the outdoor product segment meets our usual high Rolf Benz quality standards.

The Rolf Benz outdoor fabric collection guarantees the following features:



UV light-resistant



Mould-resistant



Breathable comfort



Suitable for bleaching*



Sun protection*



Water and dirt-repellent*

*For fabrics composed of spun-dyed acrylic, there may be slight color variations between the pattern and the series.

*Does not apply to fabrics with the following composition:

88 % polypropylene, 12 % polyester

86 % polypropylene, 14 % polyester

Sunbrella fabrics overview | Rolf Benz Outdoor

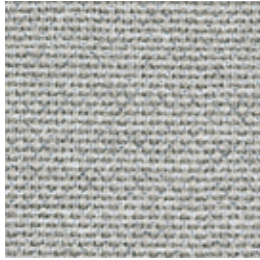

12.751

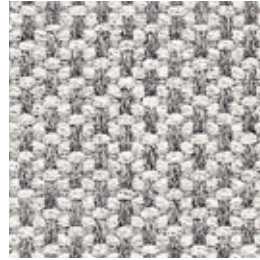

18.750

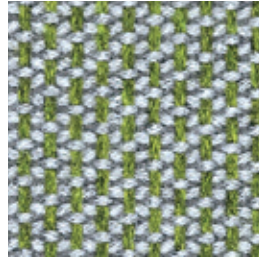

18.754

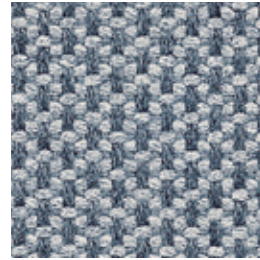

18.755

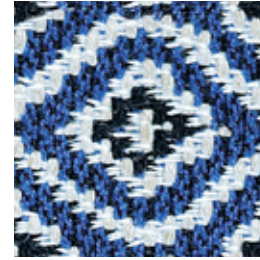

22.753



24.750



24.751



24.752



24.753

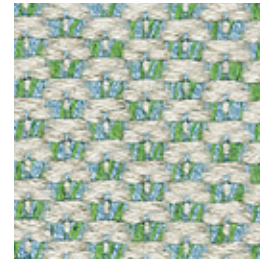

24.754

Sunbrella fabrics | Rolf Benz Outdoor

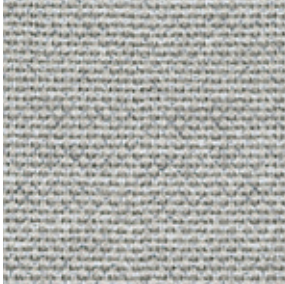

12.751

Composition:

100 % polyacrylic

Light fastness: ☀️☀️☀️

Abrasion resistance: ••

Pilling behaviour: •

Fabric width: 140 cm

Pattern repeat included: No

Selvage edge runs parallel to the front edge of the seat

Other special features: No

Washable: 30 degrees

* Scale has a maximum of three suns:

One sun: fulfilled; two suns: fulfilled +; three suns: fulfilled ++

** •• Above-averagely good; • Testing standards were completely fulfilled;

◦ Limited practicality

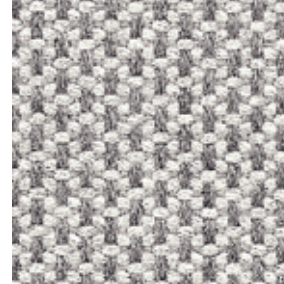

18.750 – 18.755

Composition:

99 % polyacrylic, 1 % other fibres

Light fastness: ☀️☀️

Abrasion resistance: •

Pilling behaviour: •

Fabric width: 140 cm

Pattern repeat included: No

Selvage edge runs parallel to the front edge of the seat

Special features:

Contrasting colours create an iridescent appearance.

This can create light and dark effects depending on how the light falls

Washable: 30 degrees

**ROLF
BENZ**

OUTDOOR

Sunbrella fabrics | Rolf Benz Outdoor



22.753

Composition:

99 % polyacrylic, 1 % other fibres

Light fastness: ☀️☀️☀️

Abrasion resistance: •

Pilling behaviour: •

Fabric width: 140 cm

Pattern repeat included: No

Selvage edge runs parallel to the front edge of the seat

Special features:

Contrasting colours create an iridescent appearance. This can create light and dark effects depending on how the light falls

Washable: 30 degrees

Important: For loose backrest cushions only

* Scale has a maximum of three suns:

One sun: fulfilled; two suns: fulfilled +; three suns: fulfilled ++

** •• Above-averagely good; • Testing standards were completely fulfilled; ○ Limited practicality



24.750 – 24.754

Composition:

100 % polyacrylic

Light fastness: ☀️☀️☀️

Abrasion resistance: •

Pilling behaviour: •

Fabric width: 140 cm

Pattern repeat included: No

Selvage edge runs parallel to the front edge of the seat

Special features:

Contrasting colours create an iridescent appearance. This can create light and dark effects depending on how the light falls

Washable: 30 degrees

**ROLF
BENZ**

OUTDOOR

More fabrics | Rolf Benz Outdoor

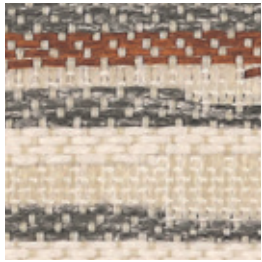

16.250

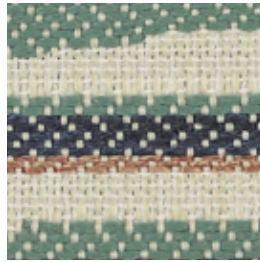

16.251

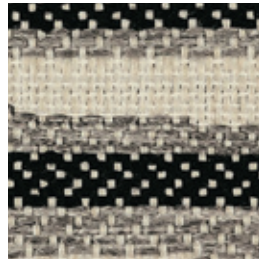

16.252



17.150



17.151



17.152

More fabrics | Rolf Benz Outdoor

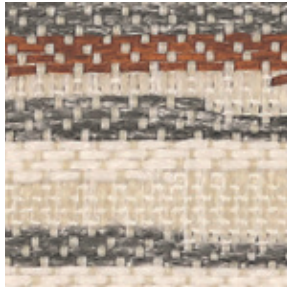

16.250 – 16.252

Composition:

86 % polypropylene, 14 % Polyester

Light fastness: ☀️☀️

Abrasion resistance: •

Pilling behaviour: •

Fabric width: 140 cm

Pattern repeat included: No

Selvage edge runs parallel to the front edge of the seat

Special features:

Contrasting colours create an iridescent appearance. This can create light and dark effects depending on how the light falls

Washable: 30 degrees

Important: Please wash separately.

Washing may cause colours to fade.



17.150 – 17.152

Composition:

86 % polypropylene, 14 % Polyester

Light fastness: ☀️☀️

Abrasion resistance: •

Pilling behaviour: •

Fabric width: 140 cm

Pattern repeat included: No

Selvage edge runs parallel to the front edge of the seat

Special features:

Contrasting colours create an iridescent appearance. This can create light and dark effects depending on how the light falls. Irregular fabric appearance due to yarn slubs, nubs etc. Dark and intensive colours have a tendency to wet abrasion.

Washable: 30 degrees

Important: Please wash separately.

Washing may cause colours to fade.

**ROLF
BENZ**

OUTDOOR

More fabrics | Rolf Benz Outdoor



20.460



20.461



20.462

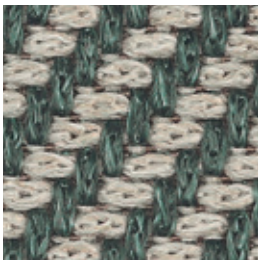

20.463

More fabrics | Rolf Benz Outdoor



20.460 – 20.463

Composition:

86 % polypropylene, 14 % Polyester

Light fastness: ☀️☀️

Abrasion resistance: • •

Pilling behaviour: •

Fabric width: 140 cm

Pattern repeat included: No

Selvage edge runs parallel to the front edge of the seat

Special features:

Contrasting colours create an iridescent appearance. This can create light and dark effects depending on how the light falls. Irregular fabric appearance due to yarn slubs, nubs etc. Dark and intensive colours have a tendency to wet abrasion. The fabric will pull if it is caught by sharp objects

Washable: 30 degrees

More fabrics | Rolf Benz Outdoor

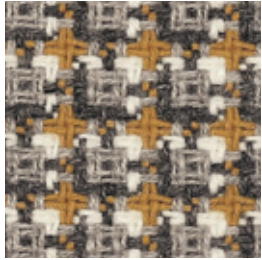

28.290

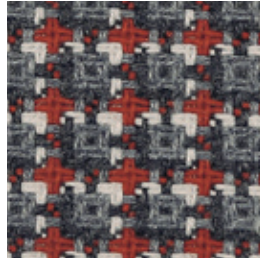

28.291

Weitere Stoffe | Rolf Benz Outdoor

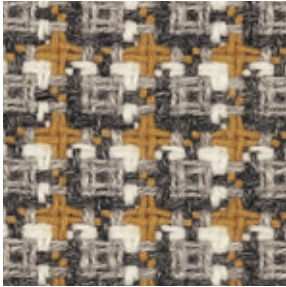

28.290

Composition:

86 % polypropylene, 14 % Polyester

Light fastness: ☀️☀️☀️

Abrasion resistance: •

Pilling behaviour: •

Fabric width: 140 cm

Pattern repeat included: No

Selvage edge runs parallel to the front edge of the seat

Special features:

Il flat-weave fabrics will roughen up through use.

The fabric will pull if it is caught by sharp objects.

Fibres from other textiles and dust may visibly attach themselves to the surface

Washable: 30 degrees



28.291

Composition:

86 % polypropylene, 14 % Polyester

Light fastness: ☀️☀️☀️

Abrasion resistance: •

Pilling behaviour: •

Fabric width: 140 cm

Pattern repeat included: No

Selvage edge runs parallel to the front edge of the seat

Special features:

Il flat-weave fabrics will roughen up through use.

The fabric will pull if it is caught by sharp objects.

Fibres from other textiles and dust may visibly attach themselves to the surface

Washable: 30 degrees

**ROLF
BENZ**

OUTDOOR

Additional fabrics in the collection overview | Rolf Benz Outdoor

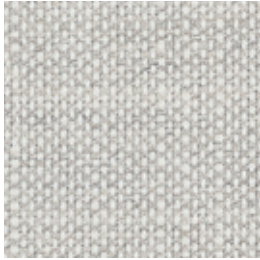

20.652

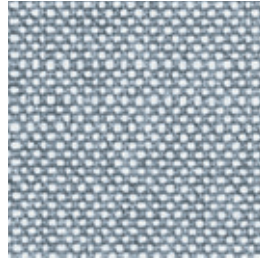

20.654

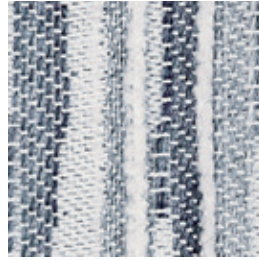

20.750

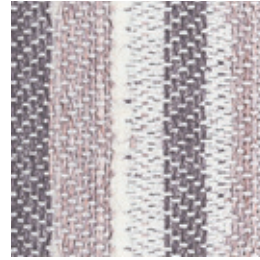

20.751

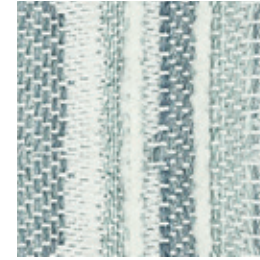

20.752

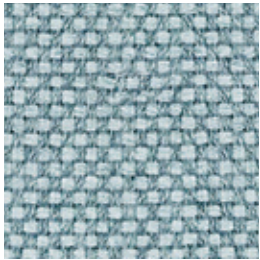

22.550

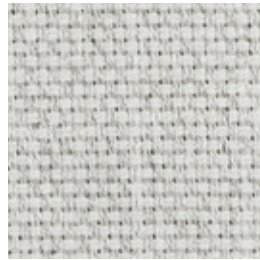

22.552

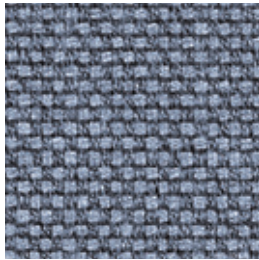

22.555

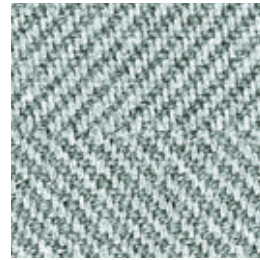

22.650

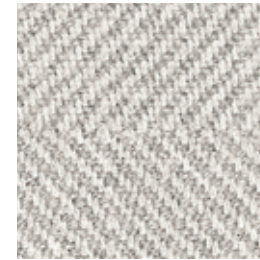

22.652

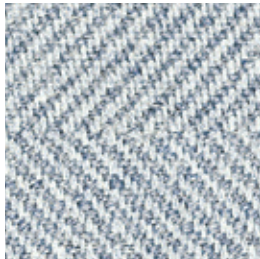

22.654

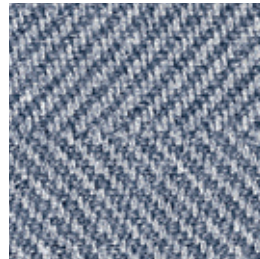

22.655



20.652 – 20.654

Composition:

100 % polyacrylic

Light fastness: ☀️☀️

Abrasion resistance: •

Pilling behaviour: •

Fabric width: 140 cm

Pattern repeat included: No

Selvage edge runs parallel to the front edge of the seat

Special features:

A slight stripy effect occurs due to the material. Irregular fabric appearance due to yarn slubs, nubs etc. The fabric's appearance reflects its natural character

Washable: 30 degrees



20.750 - 20.752

Composition:

100 % polyacrylic

Light fastness: ☀️☀️

Abrasion resistance: •

Pilling behaviour: •

Fabric width: 140 cm

Pattern repeat included: No

Selvage edge runs parallel to the front edge of the seat

Special features:

Irregular appearance, for example caused by slubs, nubs, etc.

Washable: 30 degrees

Important: For loose backrest cushions only

**ROLF
BENZ**

OUTDOOR

Additional fabrics in the collection | Rolf Benz Outdoor

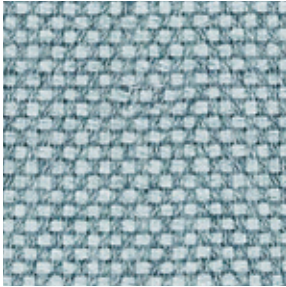

22.550 - 20.552

Composition:

100 % polyacrylic

Light fastness: ☀️☀️

Abrasion resistance: •

Pilling behaviour: •

Fabric width: 140 cm

Pattern repeat included: No

Selvage edge runs parallel to the front edge of the seat

Special features:

Irregular appearance, for example caused by slubs, nubs, etc. Fibres from other textiles and dust may visibly attach themselves to the surface

Washable: 30 degrees

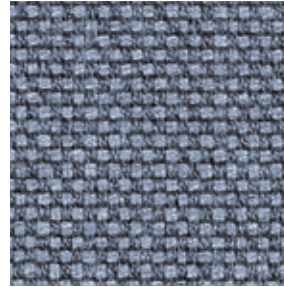

22.555

Composition: 100 % polyacrylic

Light fastness: ☀️☀️

Abrasion resistance: •

Pilling behaviour: •

Fabric width: 140 cm

Pattern repeat included: No

Selvage edge runs parallel to the front edge of the seat

Special features:

Irregular appearance, for example caused by slubs, nubs, etc. Fibres from other textiles and dust may visibly attach themselves to the surface

Washable: 30 degrees

Important: For loose backrest cushions only

**ROLF
BENZ**

OUTDOOR

Additional fabrics in the collection | Rolf Benz Outdoor

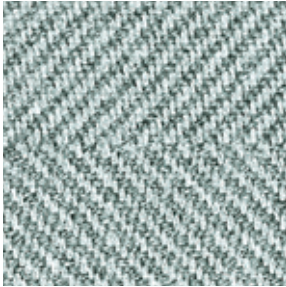

22.650 - 22.655

Composition:

100 % polyacrylic

Light fastness: ☀️☀️

Abrasion resistance: •

Pilling behaviour: •

Fabric width: 140 cm

Pattern repeat included: No

Selvage edge runs parallel to the front edge of the seat

Special features:

Fibres from other textiles and dust may visibly attach themselves to the surface

Washable: 30 degrees

**ROLF
BENZ**

OUTDOOR

Additional fabrics in the collection overview | Rolf Benz Outdoor



18.851



18.853

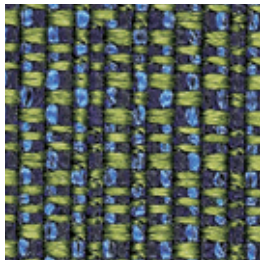

18.854

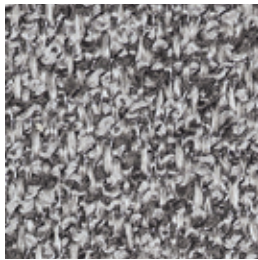

20.851



20.853

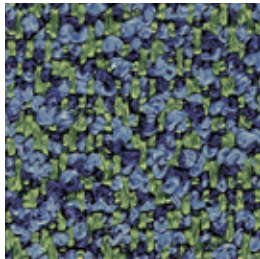

20.854



22.851



22.853

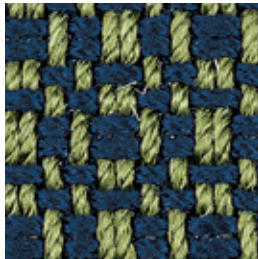

22.854

Additional fabrics in the collection | Rolf Benz Outdoor

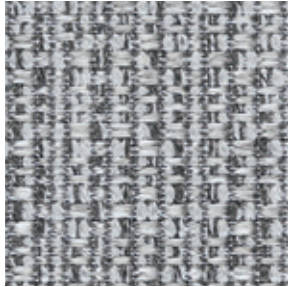

18.851 - 18.854

Composition:

86 % polypropylene, 14 % polyester

Light fastnes: ☀

Abrasion resistance: •

Pilling behaviour: •

Fabric width: 140 cm

Pattern repeat included: No

Selvage edge runs parallel to the front edge of the seat

Special features:

Contrasting colours create an iridescent appearance. This can create light and dark effects depending on how the light falls. Dark and intensive colours have a tendency to wet abrasion. The fabric will pull if it is caught by sharp objects.

Washable: 30 degrees



20.851 - 20.854

Composition:

88 % polypropylene, 12 % polyester

Light fastnes: ☀

Abrasion resistance: •

Pilling behaviour: •

Fabric width: 140 cm

Pattern repeat included: No

Selvage edge runs parallel to the front edge of the seat

Special features:

Dark and intensive colours have a tendency to wet abrasion. The fabric will pull if it is caught by sharp objects.

Washable: 30 degrees

**ROLF
BENZ**

OUTDOOR

Additional fabrics in the collection | Rolf Benz Outdoor



22.851 - 22.854

Composition: 100 % polypropylene

Light fastnes: ☀

Abrasion resistance: •

Pilling behaviour: •

Fabric width: 140 cm

Pattern repeat included: No

Selvage edge runs parallel to the front edge of the seat

Special features:

Contrasting colours create an iridescent appearance.

This can create light and dark effects depending on how the light falls. Dark and intensive colours have a tendency to wet abrasion. The fabric will pull if it is caught by sharp objects.

Washable: 30 degrees

Important: For loose backrest cushions only

Materials | Rolf Benz Outdoor

SHELVING MATERIALS



Bamboo

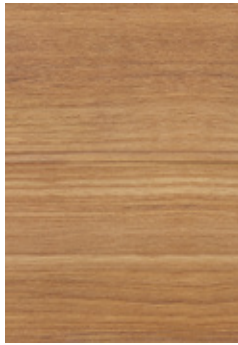

Teak

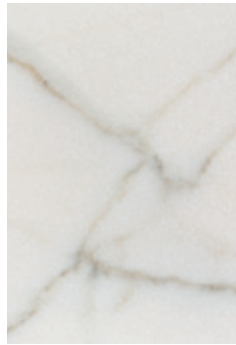

Calacatta Smooth

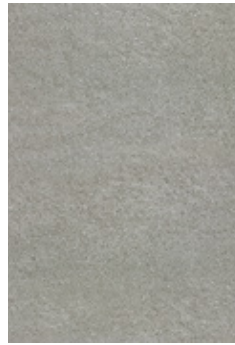

Naturali Pietre

FRAME COLOUR

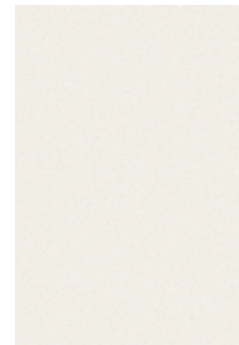

Bianco
fine-grain matt



Anthracite
matt

COLOUR OF WEAVING AND STRAPS



Cord for Anthracite
and Bianco



Strap



Strap